



A Type Overdrive, Part V Troubleshooting Tips

The following is the procedure I use to diagnose and fix OD problems. A problem in this context is that the OD is not shifting properly, or slips in OD. If the gearbox is making noises that sounds like bearings grinding and teeth breaking, or general whining, I pull the gearbox and open it and, if necessary, the OD to assess the damage.

Preliminary test: The flowchart below shows the first steps to isolate a problem. The solenoid is tested first because it's easy. The gearbox is shifted to 4th, the ignition turned on and the OD switch turned on and off. There should be an audible clunk when the solenoid operates and a clack when it releases. This clunk-clack is not to be confused with the sometimes audible click of the OD relay operating. The solenoid makes a resounding clunk-clack. Turn the OD switch on and off several times just to make sure it's operating and releasing. If it's not clear that the solenoid is operating, raise the left side of the car and slide under and see if the solenoid is operated. If it is operated, the plunger is in (up) as far as it will go --- it can't be pushed in any further. If it is operated, turn the switch off and to make sure it releases. **If it doesn't release, I don't attempt to drive the car in reverse!** If I found a problem with the solenoid I move on to the electrical trouble shooting section

If the solenoid is operating and releasing the fluid level is then checked. If the fluid is low, it is filled as necessary and the operation of the OD is retested. If the solenoid operates and releases and the oil level is correct, I move on to the hydraulic troubleshooting section.

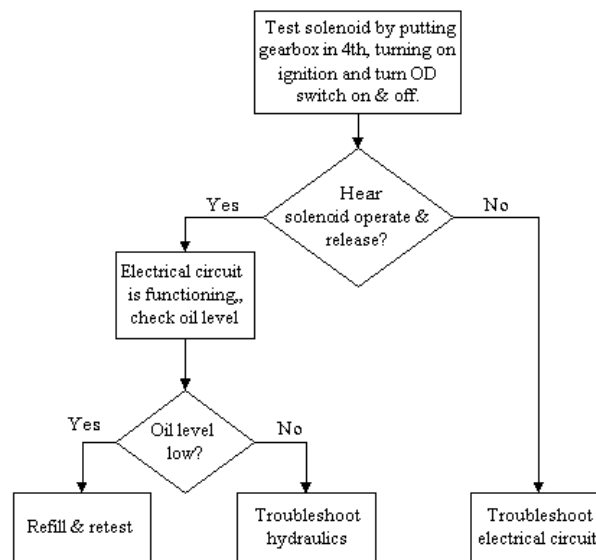

Electrical Troubleshooting

Before going further, it should be noted that one doesn't get shocked from the 12 volt auto circuitry. One can get shocked from the high voltage wires on the sparkplugs, coil and distributor, but only if the engine is running. Most of us have experienced this, and while it is unpleasant, it usually doesn't hurt unless we bump into something when we jump back. The main hazard is that one of the unfused 12 volt wires gets grounded causing the wiring to overheat and the insulation to melt. This easy to avoid --- don't connect ground to any wire carrying 12 volts.

Another problem is that while troubleshooting one problem, problems in other areas are created. This doesn't happen if only one wire or one terminal at a time is disturbed and then reconnected before moving on to another wire or terminal. Sometimes failure to follow this procedure leads to problems that show up later as another *Lucas mystery*.

Schematic: The TR6 and TR250 wiring is used as the example because I'm familiar with the specific components and their location. The approach should also be applicable to other models but the relay is in a different location. The schematic below is the same as shown in Part I but augmented with the typical wire colors (in blue) and the relay terminals (in red) for the TR250 & TR6. The wire colors are what one would expect to find on factory wiring, but the colors on my TR250 are different; maybe the supplemental harness is non standard. The relay terminals are labeled the normal way that they are connected but the wires on the W1 and W2 terminals may be reversed and the circuit will still operate properly (the W stands for winding, another term for coil). The wiring on terminals C1 and C2 can also be reversed and the circuit will still work (the C stands for contact). The circuit will not operate properly if wires are reversed between the W and C terminals.

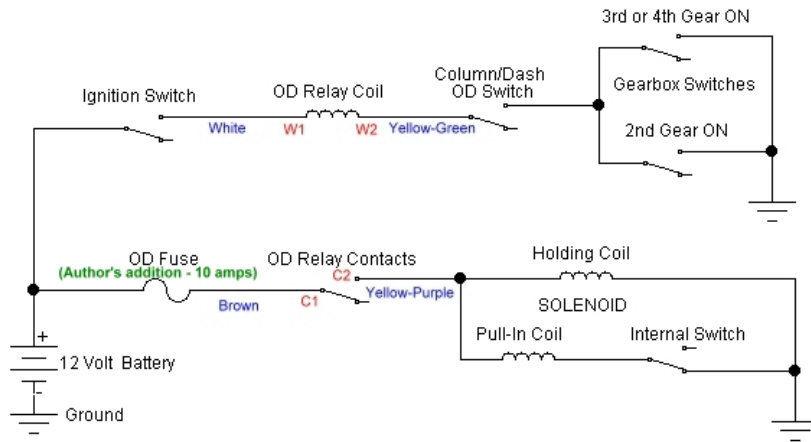

The OD Relay: The OD relay and associated wiring for my TR250 is shown in photo below. The terminals for the relay are marked and as indicated on the photo. I always check each relay to make sure the terminals are as indicated. In some cases the position of the OD relay and the Hazard relay are reversed so I'm careful to identify the OD relay as the relay that the wires from the supplemental wiring harness (in this case a tube with two wires in it) attach. The schematic shows the wire from relay contact C2 to the solenoid as yellow-green; that wire in my TR250 is green. The schematic shows the wire from relay terminal W2 to the OD switch as yellow-green; that wire in my TR250 is yellow.

The brown wire from relay contact C1 to the fuse block normally connects to the terminal on the rear side of the fuse block that the other brown wires attach. The brown wires are unfused. I added the strap from the brown wire fuse block terminal to the top fuse position which was spare and connected the brown wire from OD relay terminal C1 to the other side of the spare fuse position. A 10 amp fuse is adequate for this circuit.

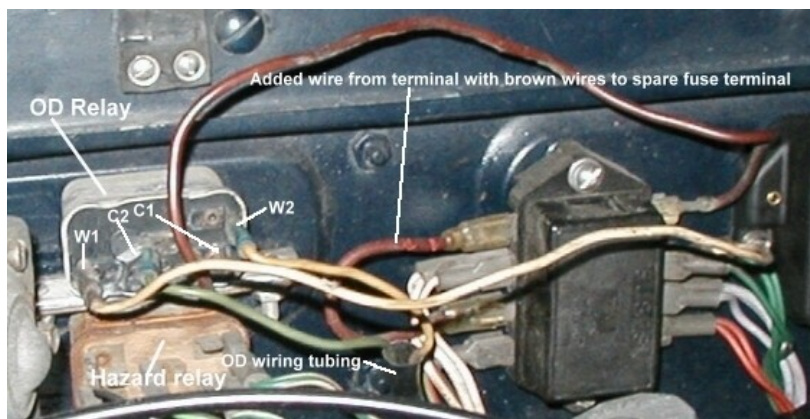

Multimeter: A test instrument is required to troubleshoot the OD electrical circuit and other Lucas mysteries. I prefer an inexpensive multimeter as shown in photo. Several of these were purchased for less than \$5 each at the electrical market in Bangalore, India several years ago; just couldn't pass up the bargain. A package of clip leads (Radio Shack) like the yellow one in the photo are also very useful.



For all the tests except the solenoid current test, the meter is set to a DC voltage scale greater than 14 volts. This one had a 20 volt scale, others may have a 15 volt scale. The black lead is connected to the common or ground terminal on the meter and the red lead is connected to the red voltage-current-resistance terminal on the meter.

Test for 12 volts: To test for 12 volts at a point in a circuit, one end of a clip lead is connected to the to the black meter lead and the other end of the lead to electrical ground. For these tests, the braided cable on the negative battery terminal makes a good ground connection. The probe at the end of the red lead is held against a terminal to see if 12 volts is present. The positive battery terminal should be checked first to verify that there is a good connection to ground, the meter is turned on, and the battery is charged. The battery should read a little over 12 volts --- 12.57 volts for the battery in the photo above.

Test for Ground: The other required test is for ground. To do this, one end of the clip lead is connected to the red meter probe and the other end to a source of 12 volts such as the positive battery terminal. The end that is attached to the probe must be covered so that it isn't inadvertently grounded leading to hot wires and melted insulation on the clip lead; masking tape around the exposed metal parts at the clip lead-red probe

connection works fine. The black probe is then used to test for ground. If the probe is held against a terminal that is connected to electrical ground, the meter will read about 12 volts. The negative battery terminal should be tested first to verify everything is set properly.

Lets go over that again --- two tests are used, one to test for the presence of 12 volts on a terminal and the other to test for ground on a terminal. To test for 12 volts, the black meter lead is connected to ground and the red probe touched to the terminal under test. The meter will read near 12 volts if 12 volts is present. To test for ground, the red meter lead is connected to a source of 12 volts and the black probe is touched to the terminal under test. If ground is present on the terminal the meter will read 12 volts again.

Does the OD relay operate? We got to this point because the solenoid didn't operate. The next thing to do is determine if the OD relay operates. The gearbox is put in 4th gear, the ignition turned on (don't start the engine), stand near the OD relay and listen while the OD switch is turned on and off. If the OD relay is operating and releasing one should hear a soft click from inside the relay case. Respond to the result as indicated by the flow chart.

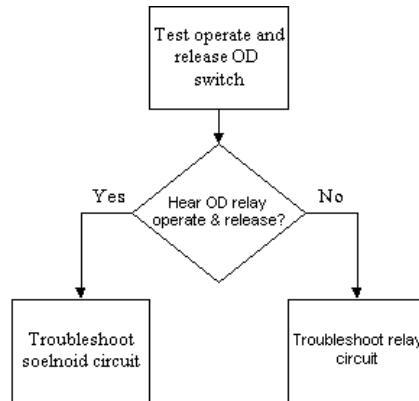

Troubleshooting the Solenoid Circuit: At this point the multimeter is used to take a few measurements. The ignition is turned on, gearbox put in 4th and the OD switched off and then the voltage at terminal C1 is measured. This is the terminal with the brown wire that goes to the fuse block. This measurement is made with the black meter lead connected to ground and the red probe on the relay terminals. It should read 12 volts. If not, the voltage at the other end of the brown wire is measured, then continue to work back to the other side of the fuse block, etc. until 12 volts is found. Once 12 volts is found, that terminal and the next one toward the relay are cleaned and pliers are used to compress the female connector terminals on the wires so that they grasp the male terminals firmly thus making a good electrical connection. Sometimes the clips that grasp the fuse in the fuse block are corroded and must be cleaned. Oh -- forgot to mention that the fuse added to the circuit could be blown. If there is 12 volts on the rear fuse terminal and no voltage on the front terminal, replace the fuse. Continue to work on this part of the circuit until 12 volts is measured at relay terminal C1. Once there is 12 volts on C1, the OD switch is operated to see if the solenoid operates. If it does, this problem is fixed and the OD is tested again. If the solenoid doesn't operate, check for 12 volts on terminal C2 and follow the flow chart.

A Type OD Part V

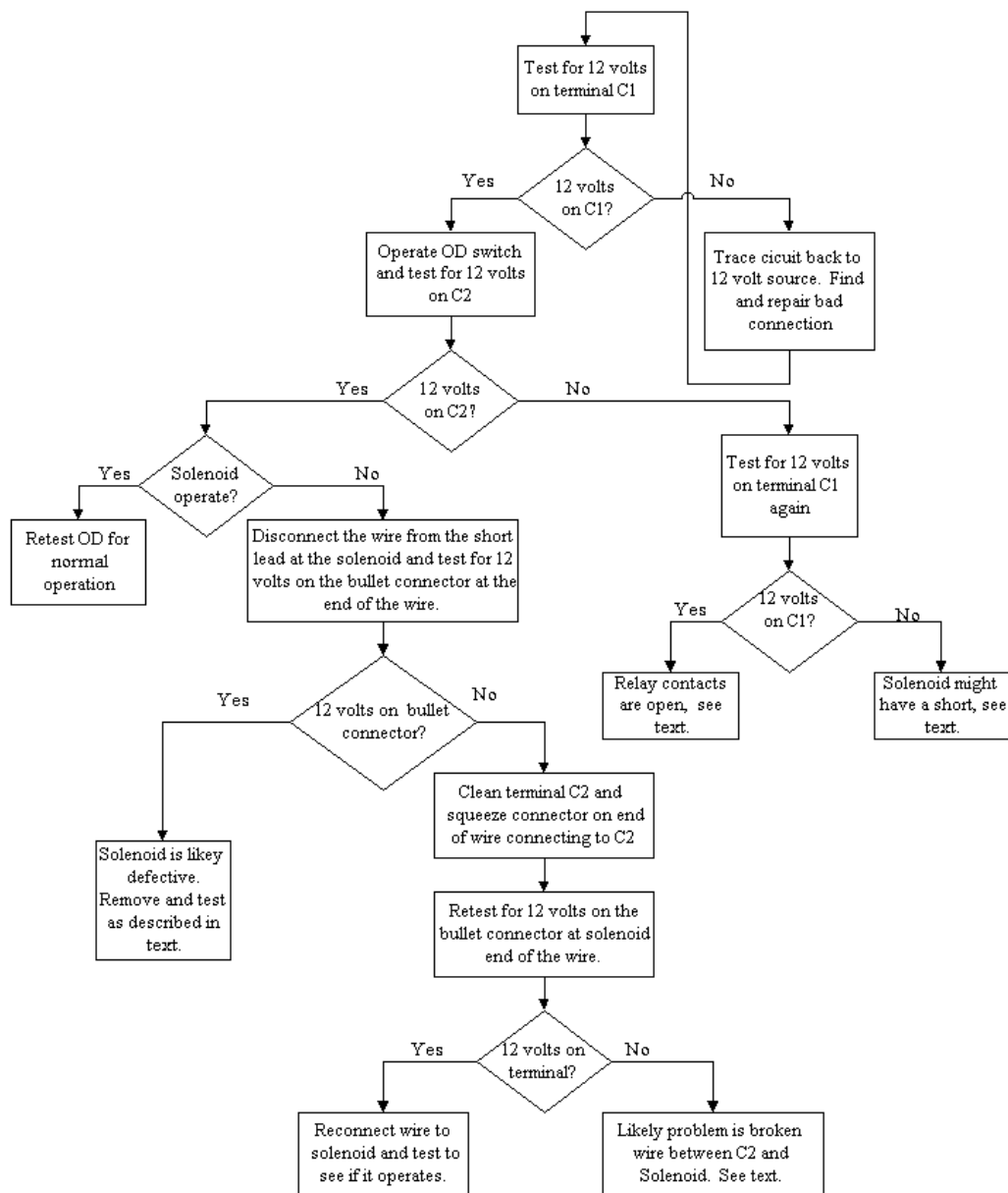

Broken wire to solenoid: If 12 volts is measured on OD relay terminal C2 and there is no voltage at the bullet connector on the other end of the wire to the solenoid, a broken wire is suspected. Before replacing the wire, string enough of the clip leads together to reach from the OD relay terminal C2 to the wire on the solenoid. The solenoid should operate when the relay operates. If not, verify that there is 12 volts on the wire at the solenoid end and if not, trace back over everything. If there is 12 volts at the solenoid and it doesn't operate, pull the solenoid and test it.

Testing the Solenoid: If the solenoid is suspect, it is tested as described in Part IV and repeated in modified form here. Because there is a possibility the solenoid is shorted, the first test is to connect a clip lead to the solenoid wire, put the plunger in the solenoid and then touch the end of the clip lead to the positive battery terminal and the solenoid case to the negative battery terminal. There should be a spark when the case is touched to the negative terminal. If the solenoid operates as indicated by the plunger snapping into the solenoid, then the solenoid doesn't have a short and it's safe to test with an ammeter in the circuit. If there was a big spark and the solenoid didn't pull the plunger into the case, the solenoid probably has an internal short.

The solenoid should draw 15 to 20 amperes with the plunger removed (this is done for only a few seconds, the solenoid is not designed to carry this current continuously). The current drain should be about 1 ampere with the plunger in place. The multimeter is set to the 20 ampere current range for this test (the red lead is moved to the high current terminal). The negative (black) probe is connected to the solenoid lead using the yellow clip lead and the positive (red) probe is held against positive battery terminal and the solenoid case is touched against the negative battery terminal.

The first test is made with the plunger removed and should read 15 to 20 amperes. Next, the current is measured with a plunger in the solenoid. When the current is applied this time, the plunger should snap the solenoid and the current should read about one ampere; the initial current is 15 to 20 amperes until the plunger reaches the back of the recess and operates a switch to remove the high current pull-in coil and leave only the low current holding coil in the circuit. If the meter reads no current, the solenoid coils are likely open.



If the solenoid has an open or short, I remove the top cover and see if there is a problem with the internal switch that I can possibly repair.

If the solenoid can't be made to pass this test, it should be replaced.

Troubleshooting the Relay Circuit: We got to this point if we didn't hear the relay operate or if the contacts appeared to be open when the relay was operated. The next flowchart is hopefully self-explanatory.

A Type OD Part V

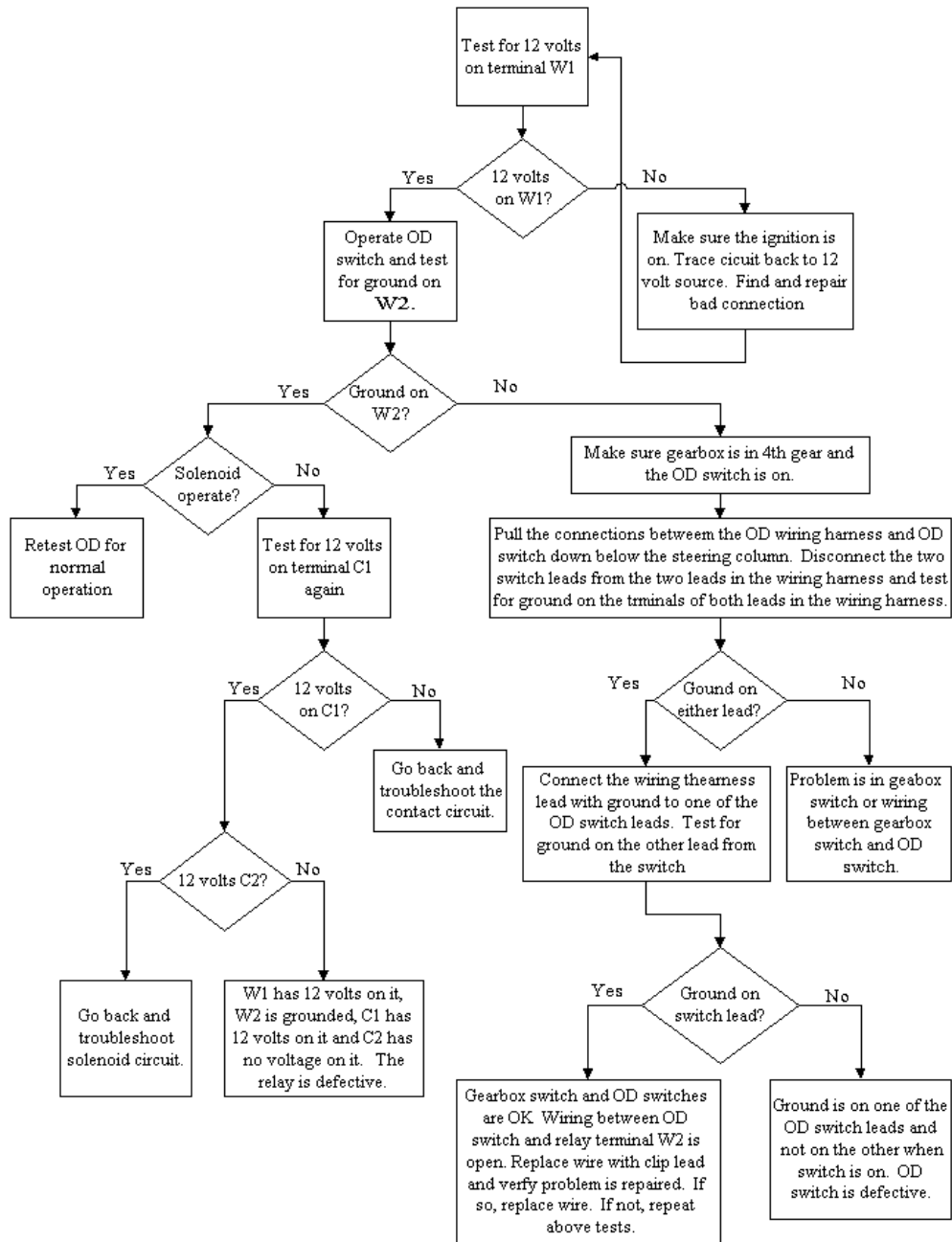

Troubleshooting Gearbox Switches: The gearbox cover must be removed to get at the gearbox switches. The next flowchart shows how to diagnose a problem with the 3rd/4th gear switch. If the electrical circuit works when the gearbox is in 3rd & 4th and not 2nd gear (and there is a switch for second gear) use the process as below to diagnose that problem, after putting the gearbox in 2nd gear instead of 4th substituting the 2nd gear switch for the 3rd/4th gear switch in the flowchart.

A Type OD Part V

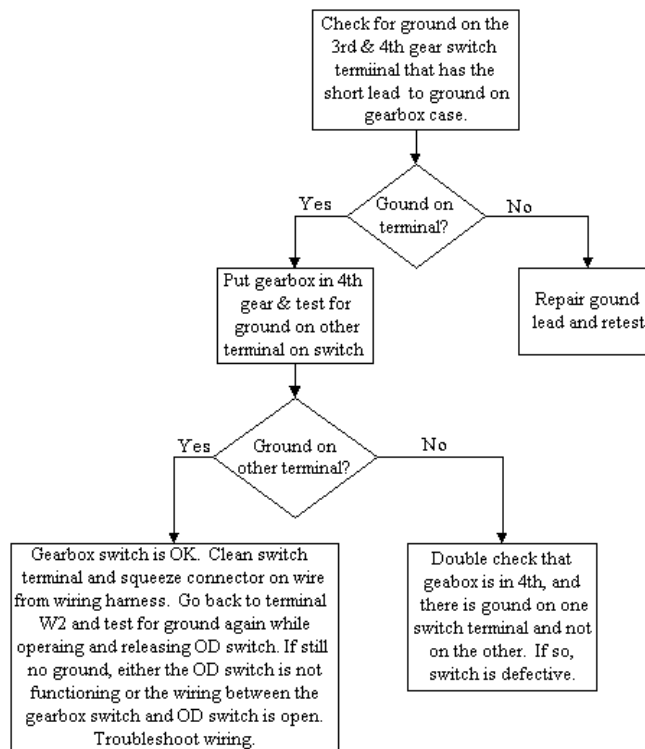

Troubleshooting the Clutches & Hydraulics

Overdrive Doesn't Engage: We got to this point after verifying that the solenoid operates and the gearbox fluid is at the correct level. The next easy thing to test is the the operating valve adjustment; merely push the lever on the operating valve shaft down to see if the OD then engages. To do this, remove the gearbox cover and then disconnect the drive shaft. The lever is on the RH side of the OD. Start the engine and put the gearbox into 4th gear, accelerate until the speedometer reads about 25 rpm and then push down on the lever. The speedometer will jump about 20% if the OD engages. If the OD engages by pushing on the lever, verify again that it doesn't engage using the solenoid by turning the OD switch on and off.

If there is any question the solenoid not causing the OD to engage, run the following test. Turn the OD switch off and then hold the solenoid plunger down and then turn the OD switch on. If you are able to keep the plunger from snapping into the solenoid with your fingers, either the gap between the engaged plunger and the stop is too great or the solenoid pull-in coil is not working. Measure the gap first and adjust it if necessary. If you can keep the plunger from engaging with a correct gap, test the solenoid as described above ----- the pull-in coil is likely not functioning.

One of my ODs was intermittent; sometimes it would shift, sometimes not. I found the solenoid pull-in coil was not functioning. The rubber cover and then the solenoid cap were removed exposing the internal switch that was found to have dirty contacts. After the contacts were cleaned it worked fine (and is still working).

If the OD can be engaged by pushing the lever and you aren't sure whether it engages reliably with the solenoid, readjust the operating valve lift using the procedure described in part IV.

OD doesn't disengage: If it is suspected that the OD isn't disengaging properly, make sure the OD is engaged by comparing the speedometer and tachometer. For 10 mph in 4th gear the rpm should be 482 with OD disengaged and 383 with the OD disengaged. For 20 mph, multiply the rpm by 2, etc. Switch the OD off and see if the rpm increases for the same speed. The switch should take place in a couple seconds or less. If it takes much longer than that to disengage or doesn't disengage at all, then the little hole in the operating valve spindle may be obstructed. The operating valve plug, spring and plunger must be removed to get at the spindle that contains the little hole. **Caution, operate and release the valve using the lever or solenoid a half dozen times to relieve the pressure before removing the operating valve plug.** Use a magnet to remove the ball and a bent wire shoved into the end of the hollow spindle to lift out the spindle. Photos of this procedure are in Part IV. Once the spindle is out, the inside of the spindle can be thoroughly cleaned and air blown through the hole to verify it is not plugged.

If the OD still appears to stick in the engaged position I would connect a pressure gauge to the top of the operating valve using the adaptor described in Part IV. **Again, caution, operate and release the valve using the lever or solenoid a half dozen times to relieve the pressure before removing the operating valve plug.** Disconnect the drive shaft, start the engine, put gearbox in 4th gear and engage the OD, then shut off the engine, put the gearbox in neutral and release the OD switch and then try to turn the OD output flange counterclockwise (as viewed from the front of the gearbox). If the flange can't be turned, the OD is still engaged. Otherwise, the OD has released. Then put the gearbox in 4th gear again and operate and release the OD switch several times (ignition switch on) while observing the pressure. The pressure should drop each time the switch is turned on and off. If it doesn't, that hole in the spindle is still plugged or the operating valve is misadjusted such that it is engaged even when the solenoid is released. Check the hole again and also verify the valve and actuating arm stop adjustments. If the pressure drops to near zero but the OD stays engaged, then it is likely the clutch release springs are too weak to push the clutch sliding member out of the brake ring -- the same problem I encountered and described in Part IV.

Clutch stuck in OD: The sliding clutch sometimes sticks in the OD position even though the operating valve has been released. Apparently this occurs after the OD has been engaged when the gearbox is cold and left engaged as the gearbox warms. One explanation for the sticking is that the clutch and brake ring expand as the temperature changes in such a way that the forces between the two increase to the point that the friction force holding them together exceeds the force provided by the clutch release springs. A clutch stuck in this way usually releases as the gearbox cools.

The clutch also usually releases if the brake ring is given a sharp rap with a hammer. If the gearbox sticks in this way frequently, then the clutch release springs are probably too weak and should be inspected.

Checking the pump operation: The easiest way to check pump action is to remove the gearbox cover and the operating valve plug. **Caution, operate and release the valve using the lever or solenoid a half dozen times to relieve the pressure before removing the operating valve plug.** Oil should be present under the plug and some will likely flow out as the plug is removed. Next, disconnect the drive shaft at the OD output flange and turn the output flange by hand. The oil level at the top of the operating valve opening should increase a small amount with each revolution of the output flange and should overflow after a half dozen revolutions. If not, the pump is not working at all. This could be caused by a defective non-operating valve, defective pump, or most likely the pump piston stuck in the down position. A stuck pump piston can be fixed by removing the drain plug (drain the oil in the process) then removing the filter screen and the pump body plug. If the pump piston doesn't move when the rear flange is rotated, then it is stuck or broken. Gently tap the piston up as the flange is rotated. If it comes free and seems to work properly, reassemble it and good luck. If it can't be freed or sticks again, then the pump must be pulled and all parts examined including the spring. **The non-return valve must be removed before the pump body can be removed - see 'Checking the Accumulator, Non-Return Valve & Pump'.**

Checking Hydraulic Pressure: The best way to check the overall health of the hydraulics is to check the hydraulic pressure. The gauge and adaptor are described in Part IV. The operating valve plug is removed and replaced with the adaptor. **Caution, operate and release the valve using the lever or solenoid a half dozen times to relieve the pressure before removing the operating valve plug.** To do this the gearbox cover must be removed. Also disconnect the drive shaft at the OD output flange. The car is started, gearbox put in 4th gear and run the speed adjusted to 25 mph. The correct pressure is 350 - 370 psi for the early units and 450 psi for the later unit (models 22/1753 & 22/1985). When the OD switch is operated, the pressure should drop and then recover in a couple seconds. If the pressure doesn't drop and the OD doesn't engage, there is probably an electrical or operating valve adjustment problem --- see previous discussion. If everything seems to operate properly but the pressure is low, then the accumulator spring is probably weak. See the accumulator discussion in Part IV.

Pressure vs. mainshaft RPM: The next thing to do is to rev the engine so that the speedometer reads about 50 mph and observe the effect on the pressure both with the OD engaged and not engaged. If the pressure changes 10 to 20 psi, then the pump, valves and rings are all in good shape --- there are no major leaks in the system. If there is a significant change in the pressure, there is probably a leak.

Checking the Operating Valve: If the pressure is low when the OD is not engaged, but much higher when engaged, then the problem may be in the operating valve ball or seat --- it is leaking when the valve is not operated but seals the end of the hollow spindle when operated. Conversely, if the pressure is higher when the valve is released, then the valve may be not sealing the end of the spindle. If the pressure is low when OD is both operated and released, then the spring may be weak and not be sealing either. Pull the spring, plunger, ball and spindle and inspect all the parts. **Caution, operate and release the valve using the lever or solenoid a half dozen times to relieve the pressure before removing the operating valve plug.** Examine the ball for scratches and measure the spring length and compare with the new spring length of ~ 0.775 inches. If the spring is 0.75 inches or less in length, replace it --- for \$2, it's not worth the hassle of opening up the unit, replace the ball too. Carefully inspect the valve seat for any signs of roughness, scratches. If it appears the valve is leaking when not engaged, and not leaking when engaged, try to improve the seat surface. The [Service Instruction Manual](#) suggests one can improve the seat by tapping the ball on the seat using a soft copper drift. I use a spare ball and a steel punch -- and then discard the ball. If the valve appears to be leaking when operated, then try to improve the valve seat in the end of the spindle by using a fine abrasive paste to grind in a spare ball --- and discard this ball afterwards too. Reassemble the unit and test again. If the pressure is low only when engaged, and you're sure that the operating valve is in order, that there is likely a leak in the operating pistons and the unit will have to be removed and disassembled.

Checking the Accumulator, Non-Return Valve & Pump: If the pressure is low when the OD is engaged and not engaged and the work on the operating valve didn't fix the problem, and the pressure increases significantly when the mainshaft rpm is doubled, then the problem is likely in the pump, accumulator or non-return valve. Check out the accumulator and non-return valve first. The oil must be drained from the OD, the solenoid, activating lever and cover plate removed. **Operate and release the operating valve using the lever or solenoid a half dozen times to relieve the pressure before attempting to remove the cover plate.** When removing the cover plate, be careful to remove the nuts from the two studs first and then back out the two long bolts together so that the cover plate stays perpendicular to the accumulator spring. Take a look at the non-return valve first by removing the spring, plunger and ball. Examine the ball for scratches and measure the spring length and compare with the new spring length as described previously for the operating valve. If the spring is 0.75 inches or less in length, replace it, and also the ball. Then pull and inspect the accumulator piston (early accumulator) or the accumulator housing (later) and inspect the piston rings and cylinder for signs of scoring. The procedures to remove and install the accumulator components are described in Parts II & III. If no problem is found with non-return valve or the accumulator, pull the pump next. The pump is extracted through the drain plug hole using the puller described in Part II. Examine the pump carefully for scratches on the cylinder or piston and check the spring length (minimum free length 2 inches). If the pump is damaged it must be replaced, the same for a too short spring.

OD slips in OD engaged: If the OD slips when it is engaged, then either the force holding the clutch to the brake ring is too small or the clutch is damaged. If the hydraulic pressure is very low, that is the likely problem. If the pressure is at or above the ~ 350 psi specification of the early units, then the problem is likely that the clutch material on the sliding member has worn thin or part of it has broken off.

OD slips in direct drive (forward): If the OD slips in direct drive in the forward direction, then the unidirectional clutch is likely damaged. Recall that the sliding member is not designed to carry the torque of forward speeds, especially 1st gear startups; the unidirectional clutch is the primarily responsible for transferring that torque.

OD slips in direct drive (reverse): If the OD slips in direct drive in the reverse direction, then the sliding clutch is likely slipping in released position. The most likely cause of the slipping is weak clutch release springs. Another possibility is a damaged clutch sliding member. Wear of the clutch material is unlikely since the load on the clutch in the rear position is very small relative to the forward position so any wear problems would likely show up in the forward position (OD engaged) first.

Experience & War Stories: Information will be added to this section as I hear of interesting OD problems and the solutions.